

**LED PL RETROFIT LAMPS**  
PL DirectFit Series Gen 3

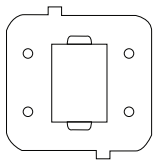

G24Q-2

18W & 26W Fluorescent  
4-Pin Replacement Bases

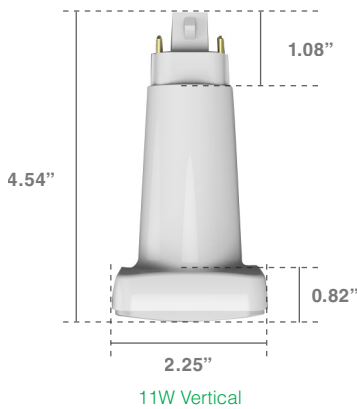
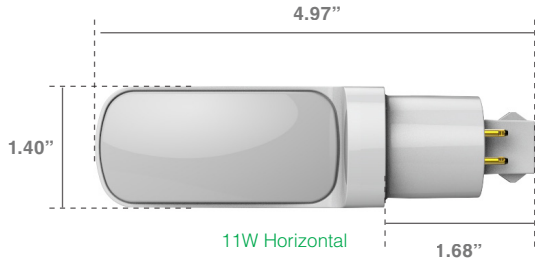
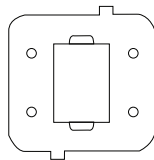

G24Q-3

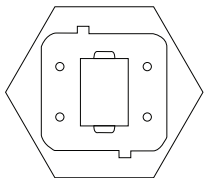

GX24Q-2

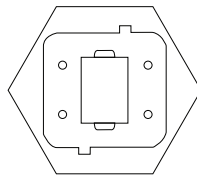

GX24Q-3

**PRODUCT DESCRIPTION:**

MaxLite LED PL DirectFit lamp is the ideal plug and play solution that works straight out of the box. The 11W LED PL lamp is designed to replace CFL downlights with 4-pin G24q sockets. These energy-saving LED lamps are quick, easy and safe to install into existing CFL fixtures without any extra effort or re-wiring. Available in horizontal and vertical installation position and 3 different correlated color temperature.

**FEATURES:**

- Lamp Wattage: (bare lamp) 11W, Average System Wattage (Lamp & Ballast): 14W
- Input Voltage: determined by CFL ballast
- Color Rendering Index (CRI): ≥80
- 50,000 Hour life
- High power factor: ≥.90
- Rotatable 270° (Horizontal model)
- Compatible with most electronic CFL ballasts
- Instant on
- Not suitable for use in totally enclosed fixtures
- Not suitable for use with dimmers
- Lamps are not intended for use with emergency exits
- Suitable for damp locations
- Five year limited warranty

**LIGHTING DESIGN LAB QUALIFIED LAMPS:**

- 11PLG24QHLED27 (Pending)
- 11PLG24QHLED35 (Qualified Date: 01/25/17)
- 11PLG24QHLED40 (Qualified Date: 08/22/16)
- 11PLG24QVLED27 (Qualified Date: 03/22/17)
- 11PLG24QVLED35 (Qualified Date: 02/24/17)
- 11PLG24QVLED40 (Pending)

**APPLICATIONS:**

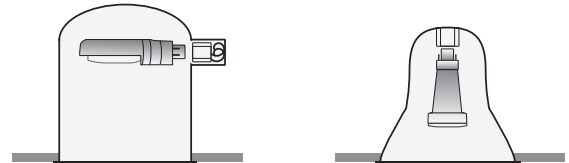

**MODEL SELECTION** (Full list of order codes on pg. 2)

Typical order example: 11PLG24QHLED27

11	PL	G24Q		
WATTAGE	FAMILY	BASE	INSTALLATION POSITION	COLOR TEMPERATURE (CCT)
11= 11 watts	PL	G24Q= G24q 4-pin	HLED= Horizontal VLED= Vertical	27= 2700K 35= 3500K 40= 4000K

**NOTES:**

1. ENERGY STAR and DLC does not currently have a category for this product type
2. Ballast compatibility list is on page 3

**SPECIFICATIONS:**

ITEM	SPECIFICATION	11W HORIZONTAL			11W VERTICAL		
		DETAILS			DETAILS		
GENERAL PERFORMANCE	Color Temperature	2700K	3500K	4000K	2700K	3500K	4000K
	Lumens Delivered (lm)	950	1000		950	1000	
	Efficacy (lm/w)	86	90		86	90	
	Lumen Maintenance (L70)	50,000 hours			50,000 hours		
ELECTRICAL	Power Factor	≥.90			≥.90		
	Input Voltage	Dependent on CFL electronic ballast			Dependent on CFL electronic ballast		
PHYSICAL	Operating Temperature	-4° F to 105° F			-4° F to 105° F		
	Weight (lbs)	0.20 lbs			0.28 lbs		
APPLICATION	Environment	Damp			Damp		
	Warranty	5 Year			5 Year		

**ORDERING\*:**

ORDER CODE	LAMP WATTAGE	MODEL	CCT	OUTPUT (LUMENS)	EQUIVALENCY
<b>11W HORIZONTAL</b>					
100945	11	11PLG24QHLED27	2700K	950	26W (32W & 42W)
100946	11	11PLG24QHLED35	3500K	1000	
100947	11	11PLG24QHLED40	4000K	1000	
<b>11W VERTICAL</b>					
100948	11	11PLG24QVLED27	2700K	950	26W (32W & 42W)
100949	11	11PLG24QVLED35	3500K	1000	
100950	11	11PLG24QVLED40	4000K	1000	

\*Please contact your MaxLite representative to order products that don't have order codes listed here.

**COMPATIBLE BALLASTS:**

BALLAST		ONE LAMP		ONE LAMP		TWO LAMP	
BRAND	MODEL	120V		277V		120V	277V
		HORIZONTAL MODEL	VERTICAL MODEL	HORIZONTAL MODEL	VERTICAL MODEL	HORIZONTAL MODEL	HORIZONTAL MODEL
HATCH	HC226PS/UV/D	✓	✓	✓	✓	✓	✓
HOWARD INDUSTRIES	EP2/26CF/MV/2	✓	✓	✓	✓	✓	✓
HOWARD IXDUSTRIES	EP2/42CF/MV/2	✓	✓	✓	✓	✓	✓
HOWARD IXDUSTRIES	EP2/13CF/MV	✓	✓	✓	✓	✓	✓
HOWARD IXDUSTRIES	EP2/18CF/MV	✓	✓	✓	✓	✓	✓
LUMAPRO	16X954 CSD-UV18PBX	✓	✓	X	X	✓	✓
LUMAPRO	16X959 CSD-UV18P/BMKIT	✓	✓	✓	✓	✓	✓
LUMAPRO	4KGJ7 EB-213PRS-U	✓	✓	✓	✓	✓	✓
LUMAPRO	4KGJ8 EB-218PRS-U	✓	✓	✓	✓	✓	✓
OSRAM	QTP 1/2x18CF/UXV DM	✓	✓	✓	✓	✓	✓
OSRAM	QTP 2x26CF/UNV DM	✓	✓	✓	✓	✓	✓
PHILIPS ADVANCE	ICF-2S13-H1-LD	✓	✓	✓	✓	✓	✓
PHILIPS ADVANCE	ICF-2S18-H1-LD	✓	✓	✓	✓	✓	✓
PHILIPS ADVANCE	ICF-2S42-M2-LD	✓	✓	X	X	✓	✓
PHILIPS ADVANCE	ICF-2S18-M1-BS	✓	✓	✓	✓	✓	✓
PHILIPS ADVANCE	ICF-2S26-M1-BS	✓	✓	✓	✓	✓	✓
PHILIPS ADVANCE	REZ-1T42-M2-LD	✓	✓	N/A	N/A	✓	X
PHILIPS ADVANCE	IZT-2S26-M5-BS	✓	✓	✓	✓	✓	✓
PROLINE	GEC226-MVPS-3W	✓	✓	✓	✓	✓	✓
PROLINE	GEC218-MVPS-BES	✓	✓	✓	✓	✓	✓
PROLINE	GEC218-MVPS-3W	✓	✓	✓	✓	✓	✓
ROBERTSON	PSM226CQMVDWCE 3P20145	✓	✓	✓	✓	✓	✓
SYLVANIA	QTP 1/2x13CF/UXV DM	✓	✓	✓	✓	✓	✓
TRAITD/UNIVERSAL LIGHTING	C213UXVME	✓	✓	✓	✓	✓	✓
TRAITD/UNIVERSAL LIGHTING	C218UXVME	✓	✓	✓	✓	✓	✓
TRAITD/UNIVERSAL LIGHTING	C2642UNVME	✓	✓	✓	✓	✓	✓
TRAITD/UNIVERSAL LIGHTING	C242UNVME	✓	✓	X	X	✓	✓

✓ COMPATIBLE  
X NOT COMPATIBLE

BALLAST		ONE LAMP		TWO LAMP	
BRAND	MODEL	347V		347V	347V
		HORIZONTAL MODEL	VERTICAL MODEL	HORIZONTAL MODEL	VERTICAL MODEL
FLEXCONNECT	E22642-347-A-TDE FLX	✓	✓	✓	✓

✓ COMPATIBLE

Specifications are subject to change without notice.