

PROJECT NAME: \_\_\_\_\_ CAT. #: \_\_\_\_\_  
 NOTES: \_\_\_\_\_ FIXTURE SCHEDULE: \_\_\_\_\_

# CPL Enhanced Canopy/Parking Garage Fixture Series

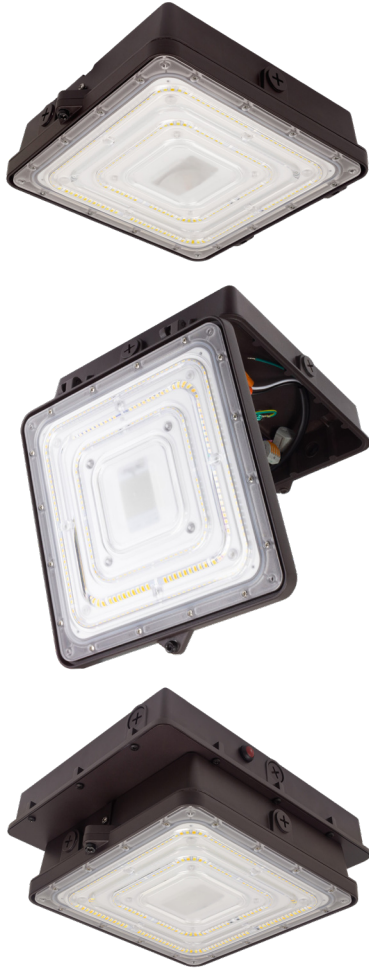

Battery Backup Model



## Product Description

Quick to install and pay for itself, the Enhanced Canopy/Parking Garage fixture is an economical retrofit solution for 70-250W HID garage and canopy luminaires. Offered in five wattages, CCT and wattage selectable, with a single lens that covers up to 4 DLC distribution categories, the CPL can address a variety of canopy/parking garage lighting needs. The series comes standard with an internal c-Max control receptacle which allows for a variety of c-Max controls to be field installed (sold separately). The luminaire also features a single screw design that allows access to the fixture interior within seconds for quick and easy surface conduit connections or c-Max controls installation. In addition, factory installed battery backup, 480V and White finish options are available. For Canopy/Parking Garage applications, this family makes it easy!

## Features

- c-Max compatible allowing a variety of field installed c-Max controls
- Third party network controls available (factory installed)
- Quick and easy access to interior with single screw and hinge design for conduit connection and controls installation
- CCT selectable between 3000/4000/5000K (5K default)
- Single lens covers up to 4 different DLC categories
- Wattage selectable on 60W version
- Shorter height for more vehicle clearance (2.67"/67.6mm)
- 18" leads standard for easier pendant mounting
- Universal 120-277V standard, High Voltage 277-480V option
- 4kV + 10kA surge protection standard, option for higher 20kA protection (40W+ versions)
- TAA compliance available - contact Maxlite for details

## Model Selection

FAMILY	WATTAGE	VOLTAGE	CCT	FINISH	CONTROL OPTIONS	EM OPTIONS	SURGE OPTIONS
CPL= Enhanced Canopy/Parking Garage	20= 20W	U= 120-277V	CS= 3/4/5K	B= Dark Bronze	CR= Controls Ready, c-Max compatible (standard)	Blank = No Battery	Blank= 4kV + 10kA (standard)
	30= 30W	H*= 277-480V	WCS**= 3/4/5K, Wattage Selectable	W= White	AV= Low-Voltage Avi-on Installed	EM2***= Battery Backup - 20°C	S= 20kA Surge Protector
	40= 40W			Contact MaxLite for additional finishes	Low-Voltage Avi-on controls (Factory installed)	Factory Installed	Factory Installed
	52= 52W						
	60= 60W - (38/48/57W)						

\* 40W, 52W and 60W only  
 \*\* 60W Wattage Selectable (38/48/57W), 120-277V only, 60W default  
 \*\*\* Battery Backup is not available in 277-480V models, only Universal 120-277V



**10-year standard warranty with labor allowance** (further details available at [www.maxlite.com/warranties](http://www.maxlite.com/warranties))

Warranty Limitations: Product must be rated for application per the Product Data Sheet (PDS); operated ≤16 hrs; in ambient temperatures -29°F to 104°F. If ambient temperatures fall outside the -29°F to 104°F range, product is warrantied for 5 years according to the operating temperature range specified on the PDS. Up to \$25/unit; registration required. Additional coverage may be available for purchase; contact MaxLite. Excludes EM/MS versions; component warranty applies.











# CPL Enhanced Canopy/Parking Garage Fixture Series

## DLC Chart

## Primary Use Designation DLC Product ID

MODEL #	LOW-BAY LUMINAIRES FOR COMMERCIAL AND INDUSTRIAL BUILDINGS	FUEL PUMP CANOPY LUMINAIRES	PARKING GARAGE LUMINAIRES	STAIRWELL AND PASSAGEWAY LUMINAIRES
CPL20UCS[ALL OPTIONS]	-	S-I9DBR5	S-Q3N8K4	S-GP7UAV
CPL30UCS[ALL OPTIONS]	-	S-LQEZ4X	S-F29D4T	S-VYJS5D
CPL40UCS[ALL OPTIONS]	S-EMJR4H	S-E1QA3N	S-09821A	S-1CU0TF
CPL40HCS[ALL OPTIONS]	S-NWHI6B	S-R32WJ5	S-61TYB8	S-4NIRLV
CPL52UCS[ALL OPTIONS]	S-ZPREM1	S-QANEMB	S-YWILKT	S-LPIN3R
CPL52HCS[ALL OPTIONS]	S-MDSBV4	S-WLQI3C	S-T1ELXI	S-6K4GD9
CPL60HCS[ALL OPTIONS]	S-OMLQFU	S-175ZY3	S-IMDAXQ	S-QNWM9Z
CPL60UWCS[ALL OPTIONS]	S-2SLX87	S-LRI9E4	S-R26D4J	S-JAGOUZ

## Accessories (SOLD SEPARATELY)

ORDER CODE	MODEL NUMBER	DESCRIPTION	IMAGE
109426	CPL-BPLATE-B	Enhanced Canopy 15inch X 15inch Beauty Plate, Bronze	
110763	CPL-BPLATE-W	Enhanced Canopy 15inch X 15inch Beauty Plate, White	
109427	CPL-VCLENS	Enhanced Canopy Visual Comfort Lens	
111294	EM2-REMOTE-MT	Field Installable Remote Mount - 20°C Battery Backup (For Universal (120-277V) Products Only)	
<b>c-Max Basic</b>			
105567	CN-REMOTE	Control Node Remote Control	
105564	CN-RTMST	Control Node Rectangular, Microwave Motion Sensor/Photocell, Translucent	
105568	CN-RTPCT	Photocell Node Rectangular, Translucent	
<b>c-Max Network</b>			
105892	NN-RTW	Network Node Rectangular, White	
108255	NN-RDMP*	Network Node Round, Pir Motion Sensor, Photocell, (*=B or W For Finish Color)	
106903	CEA-RD*	C-Max External Adapter Round (*=B Or W For Finish Color), Required For PIR Sensors	

# CPL Enhanced Canopy/Parking Garage Fixture Series

Specifications	CPL20	CPL30	CPL40	CPL52	CPL60
POWER CONSUMPTION (W)	20.5W	30.6W	40.7W (HV=39.7W)	50.2W (HV=52.5W)	38/48/57W (HV=61.1W)
LUMENS (LM)	2,490 - 2,620	3,860-4,178	5,330-5,710 (HV=5,060-5,410)	6,770-7,130 (HV=6,650-7,030)	5,160-5,540/6,520-7,000/7,760-8,130 (HV=7,910-8,370)
EFFICACY (LM/W)	121-133	128-141	132-143 (HV=128-138)	135-143 (HV=127-136)	136-146 (HV=130-140)
CRI	84+				
COLOR TEMPERATURE (K)	3000/4000/5000K Selectable (5000K Default)				
DISTRIBUTIONS	Single Lens covers up to 4 DLC categories (see DLC Chart)				
VOLTAGE	120-277V		120-277V or 277-480V option		
DIMMING	0-10V, compatible with c-Max Controls standard				
SURGE PROTECTION	4kV integral to driver + 10kA stand alone standard, 20kA option				
BATTERY BACKUP	-20°C Battery Backup option factory installed (back box), 8W, 800-950 lumens, only for 120-277V models				
LUMEN MAINTENANCE (L 70) HRS	100,000+ Hours				
HOUSING	Die Cast Aluminum with corrosion resistant polyester powder coat 4 1/2" conduit holes (one on each side), 3/4" top hub for pendant mounting				
LENS	Polycarbonate				
MOUNTING	Surface: Hinged metal mounting plate holds fixture to connect wires, hinged housing design with single screw for quick access to interior for surface conduit connection; Pendant: 18" leads standard to make wiring easier				
OPERATING TEMPERATURE	-40°C/-40°F - 40°C/104°F (10 Year Warranty), -40°C/40°F - 50°C/122°F (5 Year Warranty based on outdoor dusk to dawn operation in non-hazardous applications)				
WEIGHT	6 lbs (2.75 kg)				
LISTINGS	UL, FCC, TAA Available				
DLC	Premium - Low-Bay Luminaires for Commercial and Industrial Buildings, Fuel Pump Canopy Luminaires, Parking Garage Luminaires, (Check DLC Chart for wattage limitations)				
ENVIRONMENT	IP65, RoHS				
WARRANTY	10 Years (see Maxlite warranty page for details)				

## Dimensions

Housing and Standard Lens

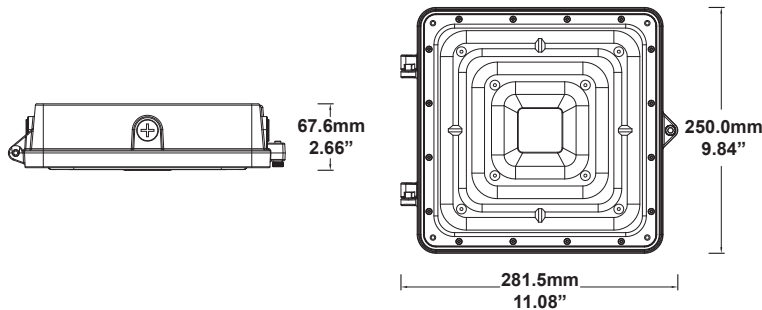

Housing and Visual Conform Lens

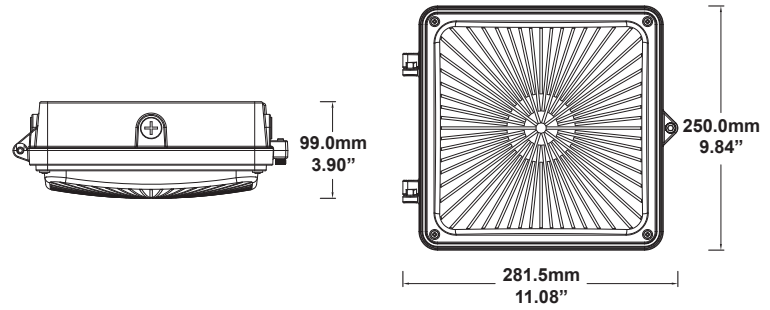

EM Housing and Standard Lens

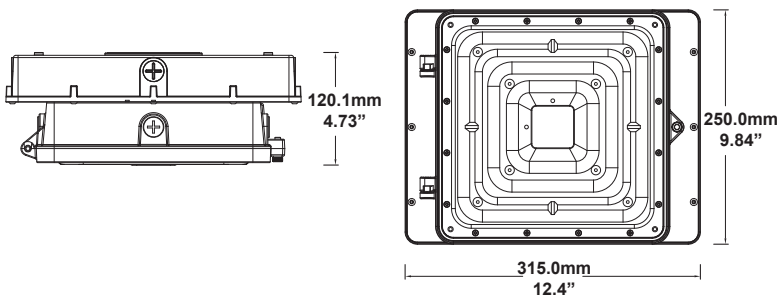

EM Housing and Visual Conform Lens

