

FLOODMAX FM SERIES



FMS 20/30W



FMM 50/80W



FML 120W



FMX 200/310W



PRODUCT DESCRIPTION:

The FloodMax family of fixtures combines performance and design in a value package. It is available in 4 sizes and 7 wattages ranging from 20W-310W. The smaller sizes come with 1/2" threaded adjustable knuckle slipfitter or a trunnion. The larger sizes come with either a 2 3/8" adjustable knuckle slipfitter or a trunnion. Typical applications include general area lighting, façade, landscape as well as signage.

FEATURES:

- 2,500 to 40,000 lumens
- 120-277V 0-10V driver, 347-480V option (30W+ versions)
- Wide distribution standard (NEMA 6x6 or 7x7); Narrow distribution (NEMA 3x3) option
- CRI: >70
- Photo control (2 fixtures in one):
 - 120-277V button PC with removable cap included on 20-80W
 - NEMA twist lock receptacle with removable shorting cap included on 120-310W
- 10KV surge protection standard
- 5 year warranty

CONSTRUCTION:

- Die cast aluminum housing with integrated heat sinking to maximize performance and fixture life
- Polyester powder coat finish provides corrosion resistance

MODEL SELECTION		Typical order example: FML120UW-40BSKRPC						
FAMILY	WATTAGE	VOLTAGE	DISTRIBUTION	-	CCT	COLOR	MOUNTING	CONTROLS
FMS= FloodMax Small (20/30W)	20= 20W 30= 30W	U= Universal 120-277V H= 347-480V (50W+)	N= Narrow W= Wide		40= 4000K 50= 5000K	B= Bronze	KT= Knuckle with 1/2" thread (20/30/50/80W) SK= Slipfitter Knuckle (50/80/120/200/310W) TS= Trunnion Swivel (All versions)	Included Standard with 20/30/50/80W PC= 120V-277V button photocell with removable cap Included standard with 120/200/310W RPC= 3-pin NEMA twist lock receptacle with shorting cap Option for 120/200/310W PR7= 7-pin NEMA twist lock receptacle
FMM= FloodMax Medium (50/80W)	50= 50W 80= 80W							
FML= FloodMax Large (120W)	120= 120W 200= 200W 310= 310W							
FMX= FloodMax XL (200/310W)						Contact Maxlite for additional finishes.		

SPECIFICATIONS:

DETAILS

ITEM	SPECIFICATION	20W	30W	50W	80W	120W	200W	310W	
GENERAL PERFORMANCE	Output (lm)	2,300-2,500	3,400-3,700	6,900-7,400	9,900-10,600	14,350-15,300	29,590-31,100	39,600-41,600	
	Efficacy (lm/W)	119	115	131	133	130	135	129	
	Beam Spread Narrow (NEMA/Beam Angle)	3x3/20.8°-20.3°						3x3/19.9°-20.2°	
	Beam Spread Wide (NEMA/Field Angle)	7x7/137°-148°		6x6/128°-125°	6x6/128°-128°	6x6/126°-124°	6x6/129°-124°	6x6/125°-130°	
	Max Candela (Narrow/Wide)	13,416/931	19,706/1,384	39,809/3,173	57,127/4,415	82,406/7,109	156,782/14,118	209,882/21,247	
	Color Temperature (CCT)	4000K or 5000K							
	CRI	>70							
	Lumen Maintenance (L90) hrs	>100,000							
ELECTRICAL	Wattage (W)	19.5	29.5	52.7	74.4	110.5	218	307	
	Power Factor	>0.90							
	Input Voltage	120-277V; 347-480V option							
PHYSICAL	Housing	Die Cast Aluminum							
	Lens	Tempered Glass			UV stabilized Polycarbonate				
	Weight	10.5pds/4.7kg		11.5pds/5.2kg		16.9pds/7.7kg	19.3pds/8.75kg		
	Mounting	1/2" Threaded Knuckle or Yoke		1/2" Threaded knuckle, Slipfitter or Trunnion		Slipfitter or Trunnion			
	EPA	0.25		0.68		0.97	1.53		
	Operating Temperature	-22F/-30C - 104F/40C					-40F/-40C - 104F/40C		
QUALIFICATION	Certification	cUL, FCC, IK08 (FMS requires vandal shield), 1.5G ANSI vibration rated							
	Environment	Wet locations and IP65							
	Warranty	5 Year							

ORDERING:

ORDER CODE	MODEL	WATTAGE	EQUIVALENT	LUMENS	NEMA DISTRIBUTION (H X V)	MOUNTING	CCT
14100143	FMS20UW-40BKTPC	20W	50W HID	2,300-2,500	7X7	1/2" threaded knuckle	4000K
14100144	FMS20UW-50BKTPC	20W	50W HID	2,300-2,500	7X7	1/2" threaded knuckle	5000K
14100145	FMS30UW-40BKTPC	30W	100W HID	3,400-3,700	7X7	1/2" threaded knuckle	4000K
14100146	FMS30UW-50BKTPC	30W	100W HID	3,400-3,700	7X7	1/2" threaded knuckle	5000K
14100147	FMM50UW-40BKTPC	50W	150W HID	6,900-7,400	6x6	1/2" threaded knuckle	4000K
14100148	FMM50UW-50BKTPC	50W	150W HID	6,900-7,400	6x6	1/2" threaded knuckle	5000K
14100149	FMM80UW-40BKTPC	120W	250W HID	9,900-10,600	6x6	1/2" threaded knuckle	4000K
14100150	FMM80UW-50BKTPC	120W	250W HID	9,900-10,600	6x6	1/2" threaded knuckle	5000K
14100155	FML120UW-40BSKRPC	120W	400W HID	14,350,15,300	6x6	Slipfitter Knuckle	4000K
14100157	FML120UW-40BTSRPC	120W	400W HID	14,350,15,300	6x6	Trunnion	4000K
14100156	FML120UW-50BSKRPC	120W	400W HID	14,350,15,300	6x6	Slipfitter Knuckle	5000K
14100158	FML120UW-50BTSRPC	120W	400W HID	14,350,15,300	6x6	Trunnion	5000K
14100159	FMX200UW-40BSKRPC	200W	750W HID	29,590-31,100	6x6	Slipfitter Knuckle	4000K
14100161	FMX200UW-40BTSRPC	200W	750W HID	29,590-31,100	6x6	Trunnion	4000K
14100160	FMX200UW-50BSKRPC	200W	750W HID	29,590-31,100	6x6	Slipfitter Knuckle	5000K
14100162	FMX200UW-50BTSRPC	200W	750W HID	29,590-31,100	6x6	Trunnion	5000K
14100163	FMX310UW-40BSKRPC	310W	1,000W HID	39,600-41,600	6x6	Slipfitter Knuckle	4000K
14100165	FMX310UW-40BSKRPC	310W	1,000W HID	39,600-41,600	6x6	Trunnion	4000K
14100164	FMX310UW-50BSKRPC	310W	1,000W HID	39,600-41,600	6x6	Slipfitter Knuckle	5000K
14100166	FMX310UW-50BTSRPC	310W	1,000W HID	39,600-41,600	6x6	Trunnion	5000K

ACCESSORIES

ITEM ACCESSORY	ITEM NAME	DESCRIPTION	ITEM IMAGE
VISORS	FMS-VISOR-B	Top or Bottom Visor (order 2 for full visor)	
	FMM-VISOR-B	Top or Bottom Visor (order 2 for full visor)	
	FML-VISOR-B	Top or Bottom Visor (order 2 for full visor)	
	FMX-VISOR-B	Top or Bottom Visor (order 2 for full visor)	
Photocontrols	6390LBK	Twist-Lock Electronic Photocontrol 120/208/240/277V- FML/FMX Only	
	6394LL	Twist-Lock Electronic Photocontrol 432-528VAC- FML/FMX Only	
Tennon Reducer	101679	Tennon Reducer, 2-3/8" to 1/2", Bronze	
Vandal Shield	FMS-VANDAL	Vandal shield (IK08) for FMS series	

LINE DRAWINGS:

20W 30W with 1/2" THREAD KNUCKLE MOUNT

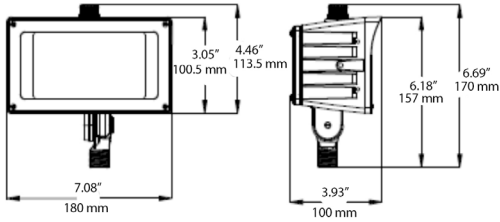

20W 30W with Trunnion Swivel



50W 80W with 1/2" THREAD KNUCKLE MOUNT

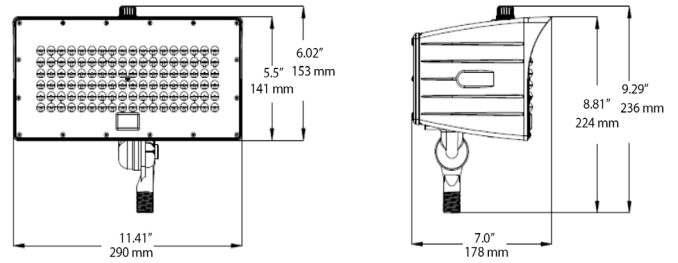

50W 80W with TRUNNION SWIVEL MOUNT



120W with Slip fitter Knuckle



50W 80W with Slip Fitter Knuckle



120W with TRUNNION SWIVEL MOUNT

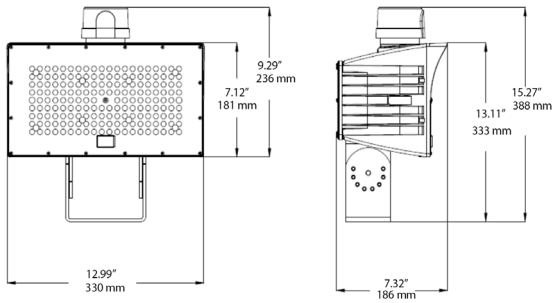

200W 310W with TRUNNION SWIVEL MOUNT



200W 310W with Slip fitter Knuckle

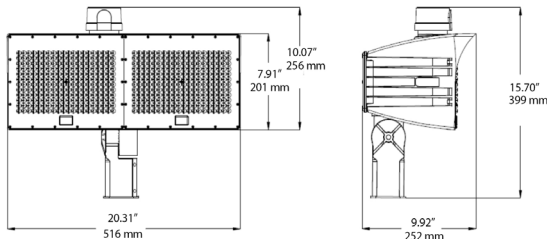

MOUNTING DIMENSIONS:



Slipfitter Knuckle (50/80/120/200/310W)

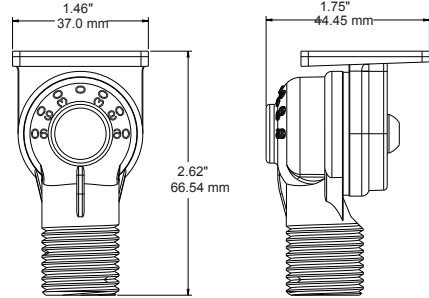

Knuckle 1/2" Thread (20/30W)

Trunnion Swivel
(50/80/120/200/310W)

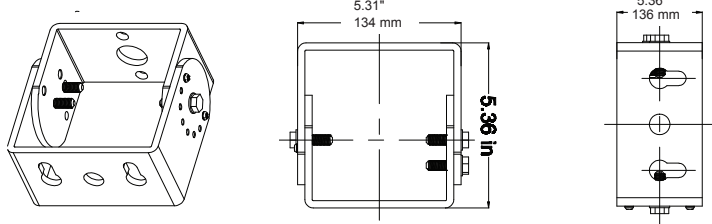

DIMENSIONS:

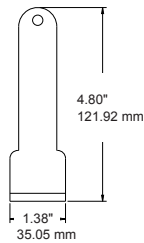

Trunnion Swivel (FMS 20/30W)

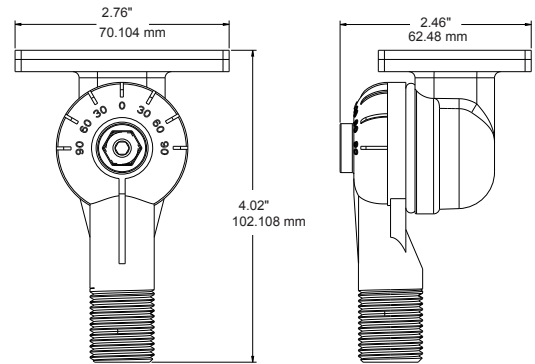

Knuckle 1/2" Thread (FMM 50/80W)

ISOFOOTCANDLE:

Each gridline represents one mounting height.
 For mounting heights other than noted multiply FC by the below factor.
 Factor = $\frac{(\text{Chart's Mtg Height})^2}{(\text{Actual Mtg Height})^2}$

LEGEND

- | | |
|--|--|
| 0.5 fc | 10 fc |
| 1 fc | 20 fc |
| 2 fc | 50 fc |
| 5 fc | |

NARROW

WIDE

20 WATT
15' ft Set back

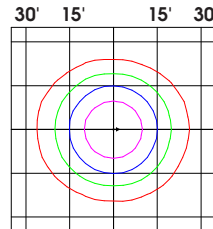
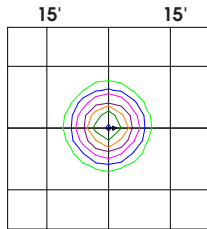

50 WATT
20' ft Set back

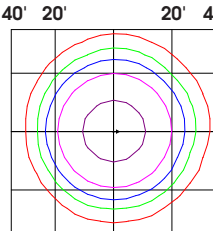
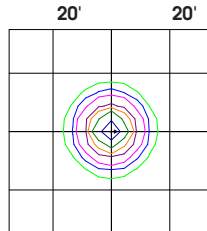

120 WATT
30' ft Set back

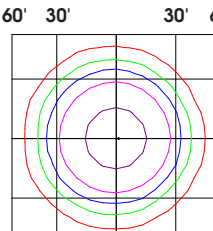
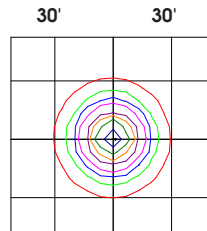

310 WATT
50' ft Set back

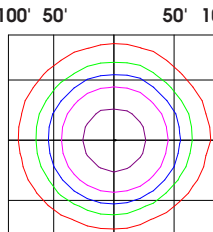
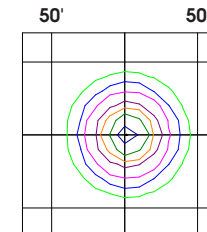

NARROW

WIDE

30 WATT
18' ft Set back

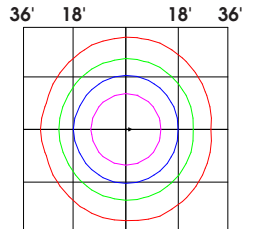
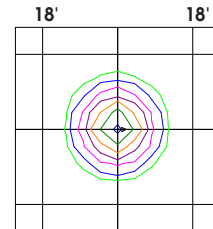

80 WATT
25' ft Set back

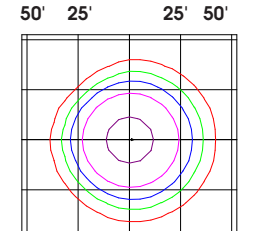
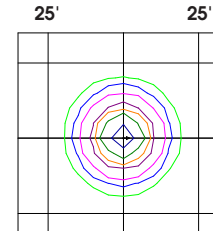

200 WATT
40' ft Set back

