

MaxLite® Hazardous Location HLRM Series



General Safety Information

- To reduce the risk of death, personal injury or property damage from fire, electric shock, falling parts, cuts/abrasions, and other hazards read all warnings and instructions included with and on the fixture box and all fixture labels.
- Before installing, servicing, or performing routine maintenance upon this equipment, follow these general precautions.
- Commercial installation, service and maintenance of luminaires should be performed by a qualified licensed electrician.
- **DO NOT INSTALL DAMAGED PRODUCT!**
- Make sure that the supply voltage is the same as the luminaire voltage.
- Do not install where the marked operating temperatures exceed the ignition temperatures of the hazardous atmosphere.
- Do not operate in ambient temperatures above those indicated on the luminaire nameplate.
- All gasket seals must be clean and undamaged.



*Pictures are for illustration purposes only.
Your model may vary.*

WARNING: RISK OF ELECTRICAL SHOCK

Luminaire shall have provision for connection to threaded rigid metal conduit or other wiring methods in accordance with Article 502 in the National Electrical Code, NFPA 70. Turn off electrical power at fuse or circuit breaker box before wiring luminaire to the power supply. Turn off the power when you perform any maintenance. Verify that supply voltage is correct by comparing it with the luminaire label information. Make sure all electrical and grounded connections in accordance with the National Electrical Code and any applicable local code requirements and Hazloc requirements and suitable for wiring system. All wiring connections should be capped with UL approved wire connectors. Luminaire must be supplied by a wiring system with an equipment grounding conductor.

CAUTION: RISK OF INJURY

Tightly close when energized for safety; Do not open the luminaire after installation; Wear gloves and safety glasses at all times when removing luminaire from carton, installing, servicing or performing maintenance; Avoid direct eye exposure to the light source while it is on; Properly handle small parts and destroy packing material, as these may be hazardous to children.

CAUTION: RISK OF FIRE

- Keep combustible and other materials that can burn away from luminaire and lamp/lens.
- MIN 90°C SUPPLY CONDUCTORS.

Model:

- HLRM Series

Power	Model	Ambient Temperature
80W	HLRM80	-40°F to +149°F (-40°C to +65°C)
120W	HLRM120	
150W	HLRM150	-40°F to +140°F (-40°C to +60°C)
200W	HLRM200	-40°F to +131°F (-40°C to +55°C)

This fixture is suitable for use in the following hazardous (classified) areas as defined by the National Electrical Code (NEC) and Canadian Electrical Code (CEC):

Hazardous Locations
 Class I, Division 2, Groups A, B, C, D
 Class II, Division 1, Groups E, F, G
 Class II, Division 2, Groups F, G
 Class III, Division 1

Refer to the luminaire nameplate for specific classification information, maximum ambient temperature suitability and corresponding operating temperature (T-Code).



MaxLite® Hazardous Location HLRM Series

General Wiring Diagram

CAUTION: Turn off electrical power at fuse or circuit breaker box before wiring fixture to the power supply.

Connecting panels to AC source supply:
All units must be individually connected to the AC supply.
Black = Line
White = Neutral
Green = Ground

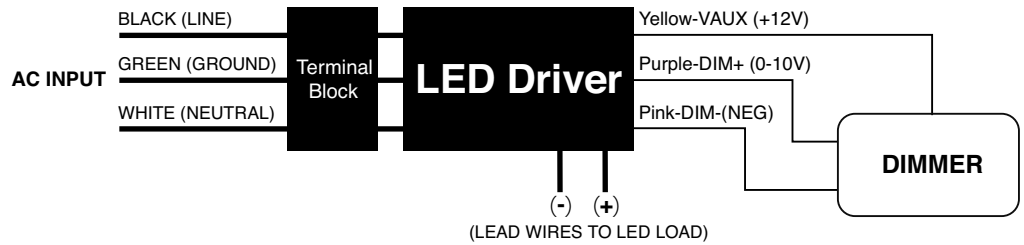

Servicing

- To avoid personal injury, disconnect power to the light and allow the unit to cool down before performing maintenance.
- Perform visual, electrical, and mechanical inspections on a regular basis. The environment and frequency of use should determine this. However, it is recommended that checks be made at least once a year. Frequency of use and environment should determine this.
- The external glass should be cleaned periodically to ensure continued luminaire performance. Clean the glass with a clean, damp, non-abrasive, lint-free cloth. If this is not sufficient, use a mild soap or a liquid cleaner. Do not use an abrasive, strong alkaline or acid cleaner as damage may occur.
- Inspect the cooling fins on the luminaire to ensure that they are free of any contamination (i.e. excessive dust build-up). Clean with a non-abrasive cloth if needed.
- Mechanically check that all parts are properly assembled.
- Electrically check to make sure that all connections are clean and tight.

This device complies with Part 15 of the FCC Rules. Operation is subject to the following two conditions:
(1) this device may not cause harmful interference, and (2) this device must accept any interference received, including interference that may cause undesired operation.

Installation and Operation

Note: For outdoor applications, ensure an M25x1.5 waterproof cable gland that meets all NEC Codes for the specified environment is used.

Electrical Connection:

1. Loosen the eight pcs of M6 hexagon bolts of Tank Cover at torque value 6 N-m.
2. The thread of entry hole of Tank is 3/4" NPT. Connect the Tank to suitable conduit.
3. Inset the wire from outside through the conduit and the entry hole of Tank, and then connect to terminal block. Introduce the wires of branch circuit as following:
Black-wire connects to Line
White-wire connects to Neutral
Green-wire connects to Ground
4. Re-attach the Tank Cover and tighten it by eight pcs of M6 hexagon bolts of Tank Cover at torque value 6 N-m.
5. Check the tightness of conduit and Tank Cover.

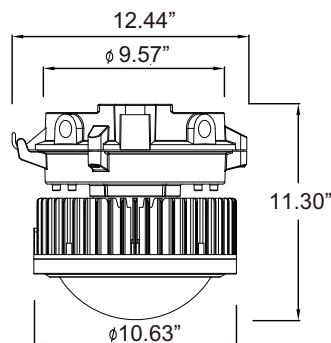
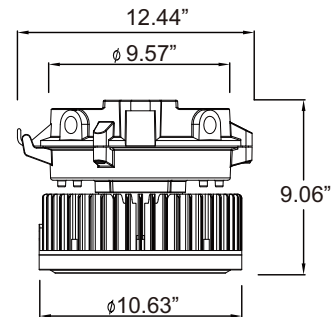

MaxLite® Hazardous Location HLRM Series

NPT Assembly Instructions

1. Inspect port and fitting to ensure that both are free of contaminants and excessive burrs and nicks.
2. Apply a stripe of an anaerobic liquid pipe sealant around the male threads leaving the first two threads uncovered. If no liquid sealant is available, wrap Teflon tape (width of 12.7mm and thickness of 0.1mm) 2.5- 3 turns in a clockwise direction, viewed from the pipe end, leaving the rest two threads uncovered.

CAUTION: Teflon tape and some pipe sealants are destructive to hydraulic components. Always use extreme caution and follow manufacturer's recommendations for proper application of any sealant in order to prevent contamination.

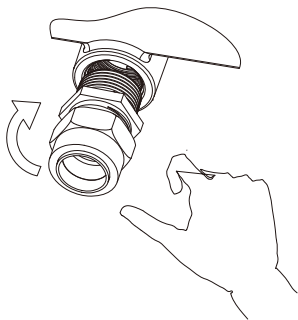
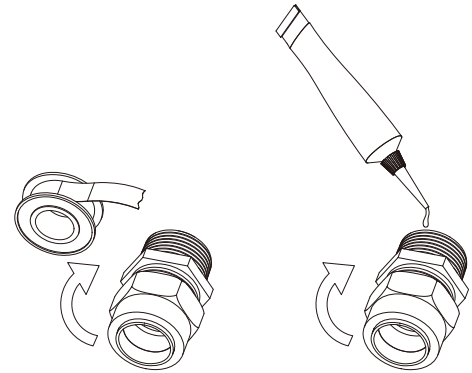

3. Screw finger tight into the port.
4. Wrench tighten the fitting to the correct turns past finger tight position. A properly assembled fittings total thread engagement should be 3.5 to 6 turns.

CAUTION: Never back off an installed pipe fitting to achieve proper alignment. Loosening installed pipe fittings will corrupt the seal and contribute to leakage and failure. (*Applicable standard: ASME B1.20.1-2013)

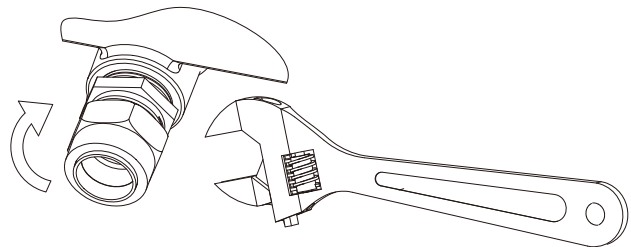



MaxLite® Hazardous Location HLRM Series

Installation Instructions – Ceiling Mount

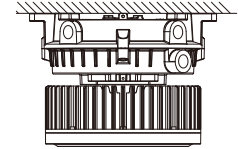
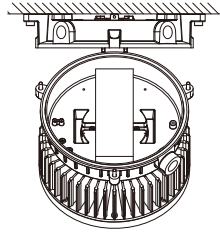
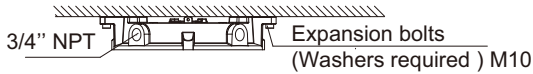

1. Mark and drill desired location on mounting surface. Secure the hood with 4 (M10) expansion bolts (not provided) directly to a structural member; thread onto a NPT 3/4 inch conduit.

2. Hang the fixture onto the hinge hook of the hood. Connect supply wires to luminaire wire leads (or Wago connectors provided)

3. Close driver housing, making sure that all wires are safely inside driver. Tighten three captive closing screw (M6) to (6 N-m).
Note: All installation must refer to "NPT Assembly Instructions" to prevent water leakage.

Installation Instructions – Bracket Mount (HLRMYB)

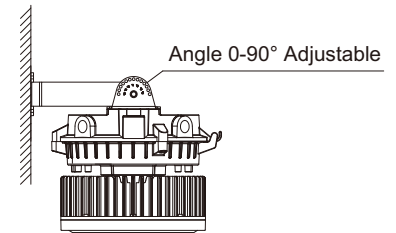
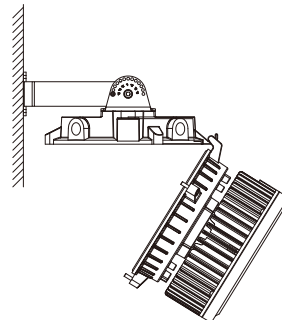
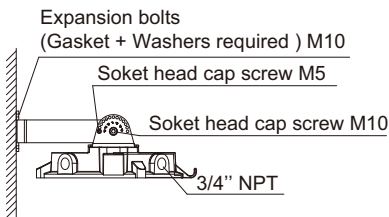

Step 3

1. Secure the bracket and hood with 4 (M10) expansion bolts (not provided) directly to a structural member; make sure the hinge is located as marked, See Figure 1a. Adjust the angle (6x15°) of the bracket and fix the position with M5 screws (provided).

2. Hang the fixture onto the hinge hook of the hood. Connect supply wires to luminaire wire leads (or Wago connectors provided)

3. Close driver housing, making sure that all wires are safely inside driver. Tighten three captive closing screw (M6) to (6 N-m).
Note: All installation must refer to "NPT Assembly Instructions" to prevent water leakage.



MaxLite® Hazardous Location HLRM Series

Installation Instructions – Pendant Mount

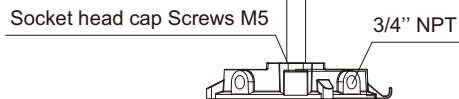

1. Thread the pendant hood onto the NPT 3/4 inch conduit. Tighten the M5 set-screw.

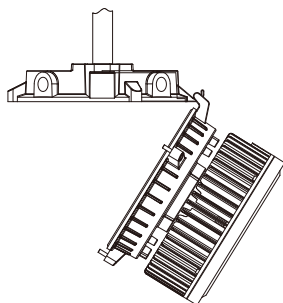

2. Hang the fixture onto the hinge hook of the hood and connect supply wires to luminaire wire leads (or Wago connectors).

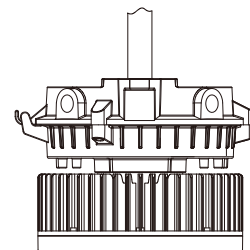

3. Close driver housing, making sure that all wires are safely inside driver. Tighten three captive closing screw (M6) to (6 N-m).
Note: All installation must refer to "NPT Assembly Instructions" to prevent water leakage.

Installation Instructions – Stanchion 90° (HLM92G/HLM94G) / Stanchion 25° (HLM22G/HLM24G)

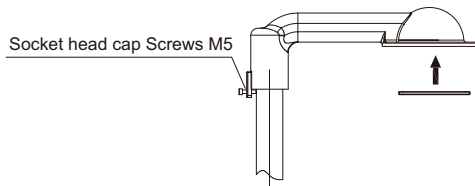

1. Securely thread the adapter onto the appropriate NPT size conduit. Determine the appropriate orientation and tighten the M5 set-screw. Make sure the gasket of the adapter is properly inserted into the slot.

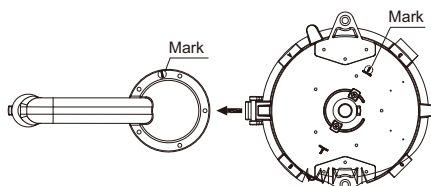

2. Hang the whole fixture onto the adapter, align as marked.

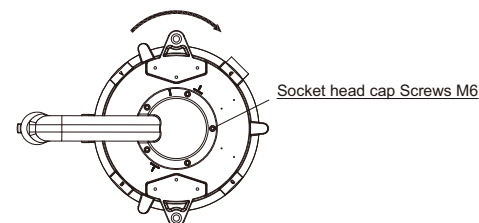

3. Rotate the fixture clockwise and secure the adapter with M6 screws (provided) to (5 N-m).

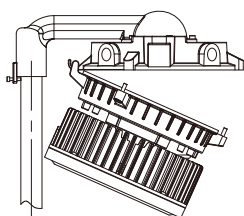

4. Unscrew the hood and connect supply wires to luminaire wire leads (or Wago connectors).

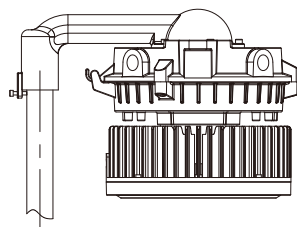

5. Close driver housing, making sure that all wires are safely inside driver. Tighten three captive closing screw (M6) to (6 N-m).
Note: All installation must refer to "NPT Assembly Instructions" to prevent water leakage.



MaxLite® Hazardous Location HLRM Series

Installation Instructions – Wall Mount 90° (HLRMW90G)

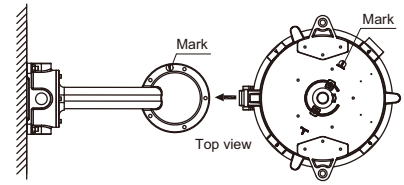
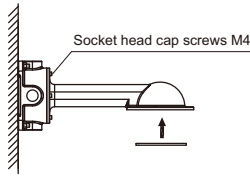
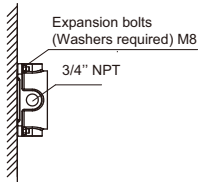

1. Mark and drill desired location on mounting surface, secure the junction box (provided) with 4 (M8) expansion bolts (not provided) directly to a structural member; thread onto a NPT 3/4 inch conduit.

2. Pull field wiring into the wall mount adapter, secure the adapter with 6 (M4) screws (provided) directly to the junction box, make sure the gasket of the adapter is properly inserted into the slot.

3. Hang the whole fixture onto the adapter, align as marked.

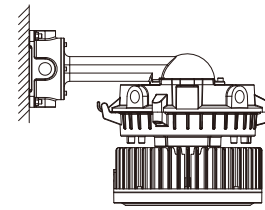
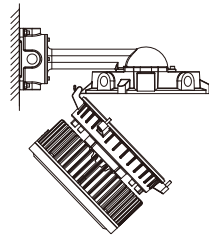
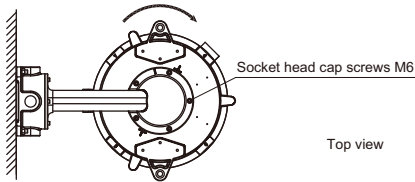

4. Rotate the fixture clockwise and secure the adapter with M6 screws (provided) to (5 N-m).

5. Unscrew the hood and Connect supply wires to luminaire wire leads (or Wago connectors).

6. Close driver housing, making sure that all wires are safely inside driver. Tighten three captive closing screw (M6) to (6 N-m).
Note: All installation must refer to "NPT Assembly Instructions" to prevent water leakage.

Installation Instructions – Tenon adapter (HL-TA) / U-bracket Mount

1. Measure and verify pole outer diameter. Place Tenon adapter on the 2-3/8" * 4" O.D. Tenon. Tighten all the provided 6 (M8x20mm) set screws. Pull cable through center hole.
2. Place and hold the fixture with bracket onto Tenon adapter. Secure with the provided 2 (M10) hex bolts and washers on the top of the Tenon adapter. This may require holding set screws in place with allen wrench.
3. Loosen the Locking Bolt of the bracket and adjust the angle (6x15°) of the fixture as desired. Tighten the Locking Bolt.
4. Wire to luminaire according to luminaire installation manual.

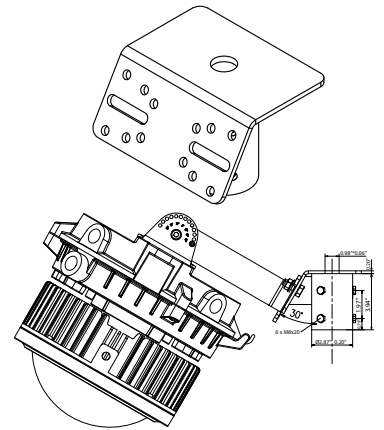

Installation Instructions – HLRMFG - Wire Guard Instructions (Sold Separately)

1. Loosen the 4 (M5) hexagon socket head cap screws of the lens cover with torque value 3 N-m.
2. Locate and center the guard to the outside of the fixture housing with the (4x) clips aligned with the holes of the screws.
3. Install and tighten the 4 (M5) screws through the mounting clips and into the housing screw holes torquing to (3 N-m).





MaxLite® Hazardous Location HLRM Series

Standard Product Warranty

TERMS & CONDITIONS

Introduction

This product warranty (the “Warranty”) covers each of MaxLite’s LED lighting fixtures, lamps, and controls (the “Product(s)”) that are purchased while the Warranty is in effect, for a specified period of time (the “Warranty Period”) from the earlier of the actual installation date or 90 days after the original date of purchase from a MaxLite authorized distributor/dealer. For each Product, the Warranty Period can be found in the most current versions of the MaxLite Standard Product Warranty Coverage document (“SPWC”) and applicable MaxLite Product Data Sheet (“PDS”).

Warranty Coverage

If a Product fails to operate during the Warranty Period as a result of defects in materials or workmanship, MaxLite will, at its option, repair it, replace it with the same Product (or, if the same Product is not reasonably available, with a product that is comparable in MaxLite’s view) at no charge, or will issue a refund. MaxLite reserves the right to utilize new, reconditioned, refurbished, repaired, or remanufactured products or parts in the warranty replacement process.

General Terms and Conditions of the Warranty

1. The Warranty is effective for purchases of Products on and after July 22, 2019. MaxLite reserves the right to modify the Warranty from time to time; any such modifications shall be effective for all purchases made on and after the effective date of such modification.
2. The Warranty is applicable only to Products originally purchased from an authorized MaxLite distributor/dealer and is otherwise void.
3. Except for Products that qualify for a labor allowance per the SPWC, MaxLite is not responsible for any of the labor costs or other expenses associated with Product removal or installation.
4. The Warranty is void if the Product is operated outside its normal operating conditions per the applicable PDS, has been installed for an application for which it is not rated, or has been subject to accident, neglect, abuse, misuse, or Acts of God, and shall only be effective if the Product has been used, installed, and maintained in accordance with MaxLite’s written instructions.
5. The Warranty shall not apply to any Product which is used, installed, operated, or maintained in violation of any applicable standard, code, or instructions for use, including without limitation, those contained in the Standards for Safety of Underwriters Laboratory, Inc (UL); the National Electric Code (NEC); Standards for the American National Standards Institute (ANSI); or, in Canada, the Canadian Standards Association (CSA).
6. The Warranty does not cover any 3rd party devices or products used in conjunction with the Product unless they are purchased from or provided by MaxLite to be used specifically with the Product.
7. Repaired and/or replacement products are warranted by MaxLite for the remainder of the failed Product’s original Warranty Period.
8. The Warranty shall not apply to Products, parts, advice, assistance, or service which a) MaxLite furnishes as a courtesy or for no fee, and/or b) that are purchased and/or used outside of the United States or Canada.
9. In the event that LEDs fail to operate, such shall constitute a Product defect under the Warranty only if at least 15% of the LEDs per product have stopped illuminating.
10. The Warranty does not cover any cosmetic Product defects, including without limitation, damage to the painted Product finish or other finish or coating. Nor does the Warranty cover any lumen drop-off or CCT (color temperature) variations experienced by a Product.
11. Only an Officer of MaxLite, or a designee appointed in writing by an Officer of MaxLite is authorized to change, modify or extend the terms of this Warranty.
12. The Warranty and all matters connected with the performance thereof shall be construed, interpreted, applied and governed in all respects by the laws of the State of New Jersey in the United States of America. Any action, suit or proceeding arising out of or relating to this Limited Warranty and/or to the purchase of Products covered by this Limited Warranty, shall be venued exclusively in the State or Federal courts located within the State of New Jersey (U.S.A.).
13. To make a claim under the Warranty, customer must notify MaxLite (or MaxLite’s designee) in writing, during the Warranty Period, of the Product failure. All claims must be initiated using the warranty claim process found on MaxLite’s website.
14. Before providing Warranty coverage, MaxLite or its designee(s): (i) may require that you provide evidence of the purchase and/or installation date (e.g. a copy of original receipt/invoice, customer order number, etc.); and (ii) shall have the right but not the obligation to inspect the relevant project job site.
15. Warranty coverage is only available if the original purchaser is not in default or arrears on any portion of its payment obligations to MaxLite for the defective Product.

LIMITATION OF LIABILITY

THIS WARRANTY IS EXCLUSIVE, AND IS THE SOLE REMEDY FOR ANY AND ALL CLAIMS, WHETHER IN CONTRACT, IN TORT OR OTHERWISE ARISING FROM THE FAILURE OF PRODUCT AND IS IN LIEU OF ALL OTHER WARRANTIES, EXPRESS OR IMPLIED, INCLUDING ALL WARRANTIES OF MERCHANTABILITY OR FITNESS FOR A PARTICULAR PURPOSE, WHICH WARRANTIES ARE HEREBY EXPRESSLY DISCLAIMED TO THE EXTENT PERMITTED BY LAW AND, IN ANY EVENT, SHALL BE LIMITED TO THE WARRANTY PERIOD SPECIFIED ABOVE. THE LIABILITY OF MAXLITE SHALL BE LIMITED TO THE TERMS OF THE EXPRESS WARRANTY SET FORTH HEREIN. IN NO EVENT WILL MAXLITE BE LIABLE FOR ANY SPECIAL, INCIDENTAL OR CONSEQUENTIAL DAMAGES INCLUDING, WITHOUT LIMITATION, DAMAGES RESULTING FROM LOSS OF USE, PROFITS, BUSINESS OR GOODWILL, LABOR COSTS, REMOVAL OR INSTALLATION COSTS, WHETHER OR NOT MAXLITE HAS BEEN ADVISED OF THE POSSIBILITY THEREOF. UNDER NO CIRCUMSTANCES SHALL MAXLITE’S ENTIRE LIABILITY FOR A DEFECTIVE PRODUCT EXCEED THE PURCHASE PRICE OF THAT PRODUCT (EXCLUDING LABOR WARRANTY COVERAGE WHERE SPECIFICALLY OFFERED BY MAXLITE). WARRANTY SERVICES PROVIDED UNDER THESE TERMS AND CONDITIONS DO NOT ENSURE THE UNINTERRUPTED OPERATION OF PRODUCTS; MAXLITE SHALL NOT BE LIABLE FOR DAMAGES CAUSED BY ANY DELAYS INVOLVING WARRANTY SERVICE.

This Warranty gives you specific legal rights and you may also have other rights that may vary from state to state. Because some states or jurisdictions do not allow the exclusion or limitation of liability for consequential or incidental damages, such limitation may not apply to you.