

LED VAPORPROOF JELLY JAR
JJ SERIES



Ceiling Mount



Wall Mount



Shown with short globe accessory



PRODUCT DESCRIPTION:

The luminaires are built for use in harsh environments, with a wide operating temperature range and integral surge protection. They are wet listed. Constructed with a tempered frosted glass lens and aluminum wire guard, the Jelly Jars provide ease of maintenance for the fixtures they replace.

FEATURES:

- IP65
- Energy Star
- 3000K/5000K available
- CRI: ≥80
- Simple installation for reduced replacement, maintenance
- Integral 6kV surge protection
- Cast-Aluminum Housing
- Color globe accessories
- Short globe accessories
- Operating Temperature: -40°F - 104°F
- Rated for 50,000 hour L70 Lifetime @TM-21 standards, 25°C
- Warranty: 5 Years

CONSTRUCTION:

- Sealed gasket protects against moisture and dust

WARRANTY:

5-year standard warranty* (further details available at www.maxlite.com/warranties)

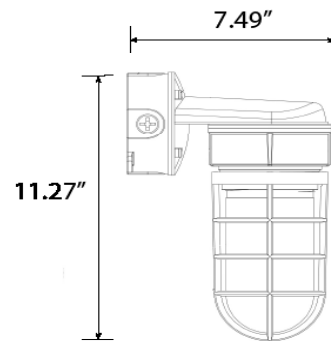
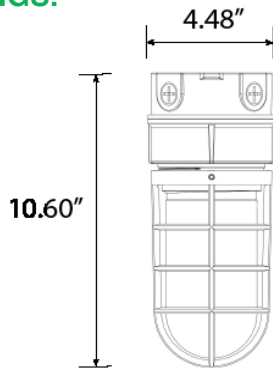

*Product may be eligible for a warranty extension to 10 years, for an additional fee. Contact MaxLite for details.

LINE DRAWINGS:



MODEL SELECTION				
JJ				
FAMILY	MOUNTING	WATTAGE	VOLTAGE	LED MODULE
JJ= Vaporproof Jelly Jar	W= Wall Mount, Gray	14= 14.5W, 100W INC. replacement	1 = 120V	30= 3000K 50= 5000K
	C= Ceiling/ Pendant Mount, Gray	23= 23W, 150W INC. replacement	U = 120-277V	

ACCESSORIES:

ORDER CODE	MODEL NUMBER	DESCRIPTION	COLOR CHIP
14100461	JJSCLEAR*	14W - 23W JELLY JAR, FROSTED PC LENS, SHORT	
14100466	JJLBLUE	14W - 23W JELLY JAR, BLUE FROSTED PMMA LENS, LONG, SET OF 2	
14100467	JJLRED	14W - 23W JELLY JAR, RED FROSTED PMMA LENS, LONG, SET OF 2	

* The luminaire is not IP rated with short globe accessory. The height with accessory is 5.15" for ceiling mount and 5.98" for wall mount

SPECIFICATIONS:

ITEM	SPECIFICATION	JJx14		JJx23	
		DETAILS			
GENERAL PERFORMANCE	Input Wattage (W)	14.5		24	
	CCT	3000K	5000K	3000K	5000K
	CRI	80			
	Lumens Output (lm)	1020	1100	1890	1890
	Efficacy (lm/W)	72	78	79	79
	Operating Temperature	-40°F to 104° F			
ELECTRICAL	Voltage	120V		120-277V	
	Power Factor	0.90			
APPLICATION	Certification	Energy Star			
	Environment	IP65, Wet locations			
	Warranty	5-year standard warranty*			

LAYOUT:

JJx14

JJx23

Each gridline represents one mounting height.

For mounting heights other than noted multiply FC by the below factor.

Factor= $\frac{(\text{Chart's Mtg Height})^2}{(\text{Actual Mtg Height})^2}$

LEGEND

-  0.2 FC
-  0.5 FC
-  1 FC
-  2 FC

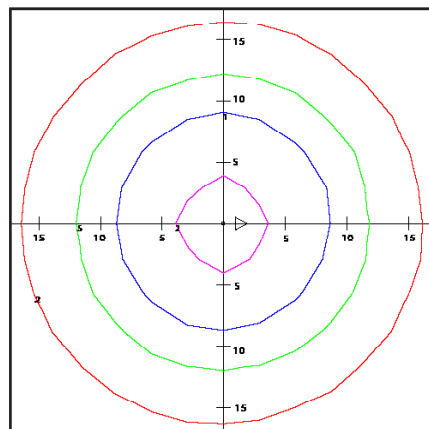

Mounting height= 8'

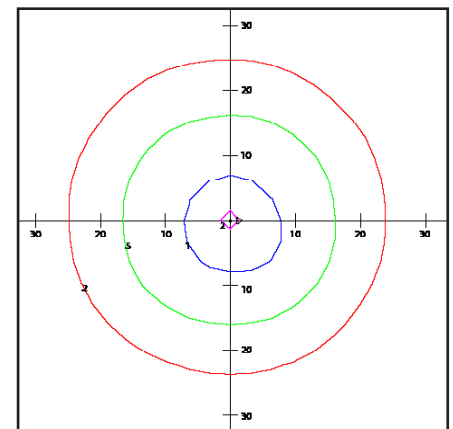

Mounting height= 15'