

LANTERN
ML4 SERIES - LAMP INCLUDED



Pagoda with Photocell



Ranch Style with Photocell



Ranch Style with Motion Sensor and dusk to dawn photocell



FEATURES:

- Includes a flicker free standard bulb (E26 base)

CONTROLS:

- Available with dusk to dawn photocell or daylight harvesting motion sensors

DIMMING:

- 120V, Triac dimming (10%)

CONSTRUCTION:

- Pagoda Style: Die cast Aluminum housing with frosted polycarbonate lens
- Ranch Style: Formed steel housing with high transmission glass lens
- Powder coat finish

LISTINGS:

- cETLus/cULus listed, Outdoor locations
- ENERGY STAR certified
- Supports T24 Part 6 high efficacy lighting requirements

WARRANTY:

5-year standard warranty (further details available at www.maxlite.com/warranties) Product may be eligible for a warranty extension to 10 years, for an additional fee. Contact MaxLite for details.

PAGODA STYLE - ORDERING STRUCTURE

FAMILY	TYPE	OUTPUT	STYLE	FINISH	CCT	OPTIONS
ML4= Lanterns	LE= Edison Base, E26	121= 1 x 11W	PL= Pagoda Style	BK= Black	27= 2700K	[BLANK]= Dusk to Dawn Photocell



RANCH STYLE - ORDERING STRUCTURE

FAMILY	TYPE	OUTPUT	STYLE	FINISH	CCT	OPTIONS	GENERATION
ML4= Lanterns	LE= Edison Base, E26	109= 1 x 09W	SPL= Low Output, Ranch Style	BK= Black WH ¹ = White	27= 2700K	[BLANK]= Dusk to Dawn Photocell MSC ² = DHL Motion Sensor and dusk to dawn photocell	-V3 ² = Gen 3
		171= 1 x 15W	RL= Ranch Style				

¹Contact MaxLite for lead time.

² Only used with the 15W models

ORDER CODE

ORDER CODES	MODEL NUMBER	ENERGY STAR PRODUCT ID	PRODUCT IMAGE
101077	ML4E121PLBK27	2334204	
101309	ML4LE109SPLBK2	2351633	
103726	ML4LE171RLBK27-V3	2334207	
14098826	ML4LE171RLBK27MSC-V3	2334207	

DIMMERS

DIMMER BRAND	MODELS
LEVITON	6631, 603-6631-A, 6631-A, 6631-LA
LUTRON	AYCL-153P-WH, AYCL-153PH, S-603PH-WH, TGCL-153PH-WH

SPECIFICATIONS

SPECIFICATION	ML4LE109SPL	ML4E121PL	ML4LE171RL
	DETAILS		
Nominal Wattage (W)	09	11	15
Source Lumens (lm)	800	1100	1600
Equivalency	60W INC	75W INC	100W INC
CRI	80	90	90
Efficacy (lm/W)	89	100	106
Color Temperature (K)	2700K		
L70 Lifetime (hrs)	≥25,000 Hrs		
Voltage	120V, Triac dimming (10%)		
Power Factor	≥0.90		
Housing	Formed Steel	Die Cast AL	Formed Steel
Lens	Glass	Polycarbonate	Glass
Mounting	Wall		
Operating Temperature	-4°F to 104°F		
Listings	cETLus, ENERGY STAR, FCC	cULus, ENERGY STAR, FCC, JA8 Compliant bulb, Title 24	cETLus, ENERGY STAR, FCC, JA8 Compliant bulb, Title 24
Environment	Damp locations, Outdoor	Wet locations, Outdoor	Damp locations, Outdoor
Warranty	5 Years		

PRODUCT DIMENSIONS

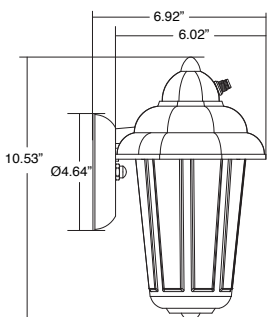

ML4E121PLBK27

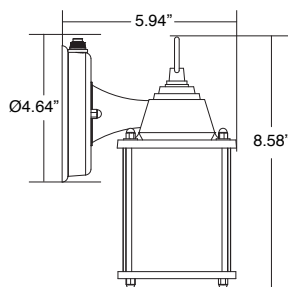

ML4LE109SPLBK2

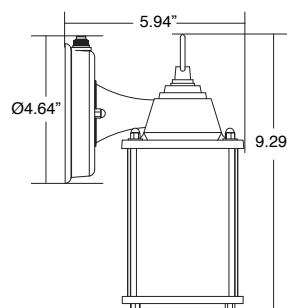

ML4LE171RLBK27

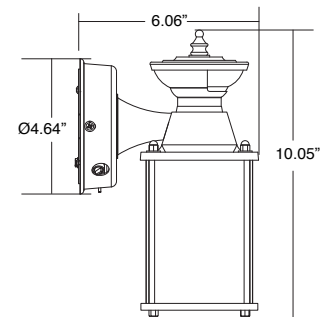

ML4LE171RLBK27MSC-V3