

WALLMAX™ OPEN FACE
WP-OP Series



DIMENSIONS:

SIZE 1 - 28W & 40W

SIZE 2 - 28W, 40W, 50W, 80W & 120W

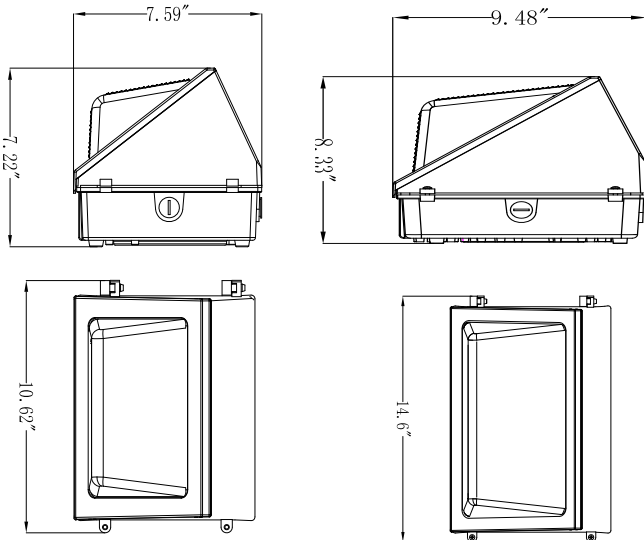

Intertek



PRODUCT DESCRIPTION:

WallMax™ Open Face Wall Packs are ideal for brightly-lit outdoor environments in parking garages, entrances, public areas, schools, hospitals, hotels and outdoor walkways nationwide. The 28-, 40-, 50-, 80-, and 120-watt LED fixtures are energy-efficient replacements for up to 750-watt metal halide fixtures. The fixtures are rebatable, save energy, generate lower maintenance costs, and prevent light pollution.

FEATURES:

- Trade Agreements Act (TAA) compliant product available - Contact MaxLite for details
- Heavy-duty cast aluminum housing is polyester powder coated to be rust and corrosion proof
- Shatter-resistant borosilicate glass
- 0-10V dimming driver standard
- 6kV integral surge suppression standard
- Six ½ NPS knockouts available
- Photo/Motion Sensor, 347-480V, Battery Back-Up options, Visors and Wire Guards available.

CONTROLS:

120-277VAC Photocontrol:

- Power the fixture when light levels reach 20 lux or below
- Turn off the fixture at 30 lux or higher

PIR Outdoor Daylight/Motion Sensor:

- Sensor provides multi-level control based on motion and/or daylight contribution for 0-10V DC Drivers
- All control parameters are adjustable remotely
- At least one FSIR-100 remote control must be ordered per project to be able to adjust factory settings for daylight / motion sensor
- For more information, please see supplementary datasheet for sensor model [MSWSFSP221B>>>](#)





WARRANTY:

10-year standard warranty with labor allowance* (further details available at www.maxlite.com/warranties)
*Warranty Limitations: Product must be rated for the application per the Product Data Sheet (PDS); operated ≤16 hrs/day; in ambient of -29°F to 104°F.
*Up to \$25/unit; labor allowances of up to \$500/unit available for purchase – contact MaxLite representative for details.

MaxLite Makes It!
Don't see what you need? Additional wattages and specifications available upon request - contact your MaxLite rep!

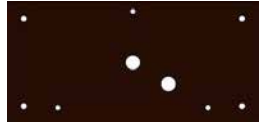
MODEL SELECTION		Typical order example: WP-OP28U-50B				
WP-OP		-		B		
FAMILY	WATTAGE	VOLTAGE	-	LED MODULE	FINISH	OPTION
WP-OP= Open Face Wall Pack	28= 28W, 150W MH replacement 40= 40W, 175W MH replacement 50= 50W, 250W MH replacement 80= 80W, 400W MH replacement 120= 120W, 750W MH replacement	U= 120-277V H= 347-480V	-	40= 4000K, CRI 80+ 50= 5000K, CRI 80+	B= Bronze Contact MaxLite for additional finishes	(BLANK)= None PC= 120-277V Photocontrol MS= PIR Daylight/Motion Sensor L= Size 2 housing EM2= Size 2 housing, Battery Backup, -20° C EM0= Size 2 housing, Battery Backup, 0° C

1. Motion Sensor performs at 20' up to 48" diameter. External model MSWSFSP221B-D will be provided on models with 120W; 347-480V; or -20 C Battery back up.
2. Use with 28W and 40W fixtures only.
3. Option L must be used with options EM0 and EM2 for all wattages.

ACCESSORIES			
ORDER CODE	MODEL NUMBER	DESCRIPTION	ACCESSORIES IMAGE
100679	WP-OP-S1PLATE-B	Beauty Plate, 14.50" X 9.50" X 0.08", Size 1, Bronze, 28W and 40W Models	
100461	WP-OP-S2PLATE-B	Beauty Plate, 18.1" * 8.7" * 0.08", Size 2, Bronze, 50W, 80W, and 120W Models	
102184	FSIR-100	Remote Control for daylight / motion sensor	
100821	WP-OP-S1VISOR-B	Cutoff Visor, Size 1, Bronze, 28W and 40W models	
100822	WP-OP-S2VISOR-B	Cutoff Visor, Size 2, Bronze, 50W, 80W and 120W models	
14099860	WP-OPSWG	Wire Guard, Size 1, Bronze, 28W and 40W models	
101499	WP-OPLWG	Wire Guard, Size 2, Bronze, 50W, 80W and 120W models	

SPECIFICATIONS:

		28W	40W	50W	80W	120W
ITEM	SPECIFICATION	DETAILS				
GENERAL PERFORMANCE	Input Power (W)	28	40	50	80	120
	Lumens Delivered (up to)	3,770	5,645	7,065	11,375	16,945
	Efficacy (up to)	136	138	138	140	140
	CRI	≥80				
	Lumen Maintenance (L85, TM-21 @ 25°C)	>100,000 hours				
	Color Temperature	4000K, 5000K				
	Spacing Criteria	Available upon request				
ELECTRICAL	Input Voltage	120-277V standard; 347-480V available				
	Power Factor	>90%				
	THD	<15%				
PHYSICAL	Housing	Die-Cast Polyester Aluminum				
	Lens	Shatter-resistant borosilicate glass				
CERTIFICATION	Certifications	ETL, IP65				
	Environment	Outdoor, wet location				
	Warranty	10-year standard warranty*				
	Operating Temperature	-40°F ~ 104°F (-40°C ~ 40°C)				
	Humidity	10%-90% RH, non-condensing				

Lighting layouts and spacing criteria available upon request.

LAYOUTS:

WP-OP 28W:

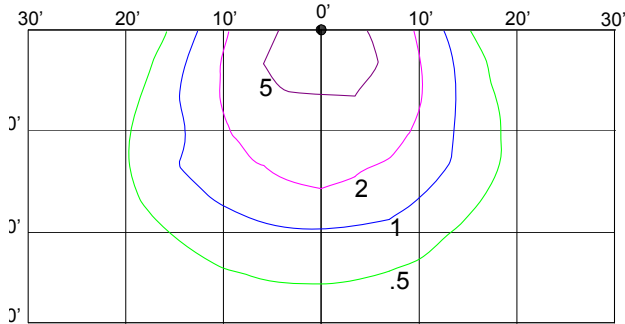

28W
3,640 LUMENS (SIZE 1 HOUSING)
10' MOUNTING HEIGHT

FOOT-CANDLE CORRECTION FACTOR:

NEW HEIGHT:	10'	15'	20'	25'
MULTIPLY BY:	1	0.67	0.50	0.40

WP-OP 40W:

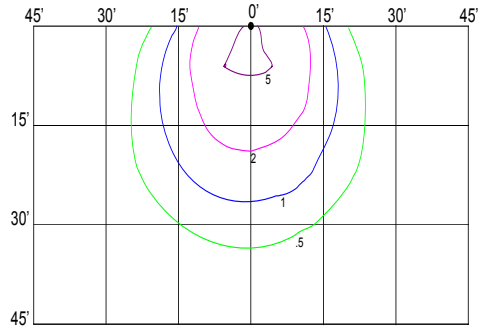

40W
5,540 LUMENS (SIZE 1 HOUSING)
15' MOUNTING HEIGHT

FOOT-CANDLE CORRECTION FACTOR:

NEW HEIGHT:	10'	15'	20'	25'
MULTIPLY BY:	1.50	1	0.75	0.60

WP-OP 50W:

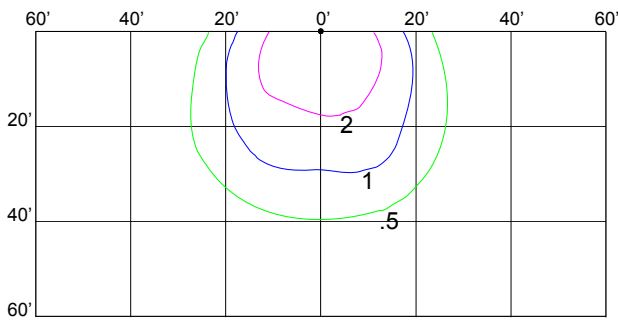

50W
7,065 LUMENS
20' MOUNTING HEIGHT

FOOT-CANDLE CORRECTION FACTOR:

NEW HEIGHT:	10'	15'	20'	25'
MULTIPLY BY:	2	1.33	1	0.80

WP-OP 80W:

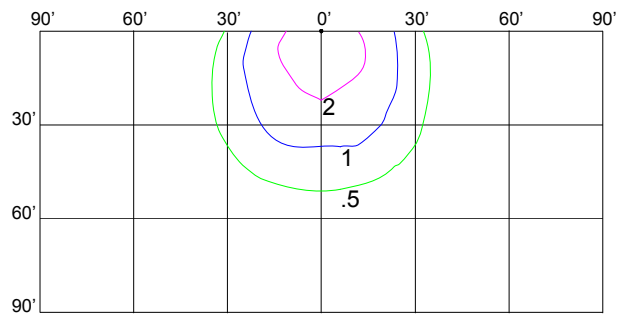

80W
11,375 LUMENS
30' MOUNTING HEIGHT

FOOT-CANDLE CORRECTION FACTOR:

NEW HEIGHT:	10'	15'	20'	25'	30'
MULTIPLY BY:	3	2	1.50	1.2	1

WP-OP 120W:

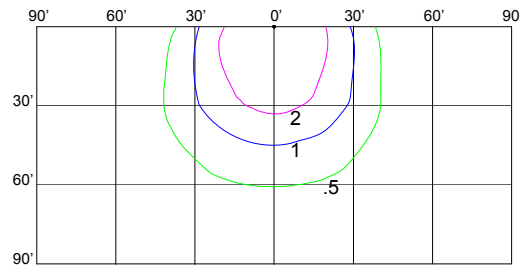

120W
16,945 LUMENS
30' MOUNTING HEIGHT

FOOT-CANDLE CORRECTION FACTOR:

NEW HEIGHT:	10'	15'	20'	25'	30'
MULTIPLY BY:	3	2	1.50	1.2	1